

SKYTECH™/R-1

INSTALLATION AND OPERATING INSTRUCTIONS

INTRODUCTION

SKYTECH'S wireless remote wall mount timer system was developed to provide a safe, reliable and user-friendly wireless remote wall mount timer for gas heating appliances. Its battery operation allows the system to operate independently of household current. The system operates on radio frequencies with non-directional signals. The SYSTEMS operating range is approximately 20 feet. The system operates on one of 255 security codes programmed at the factory.

COMPONENT

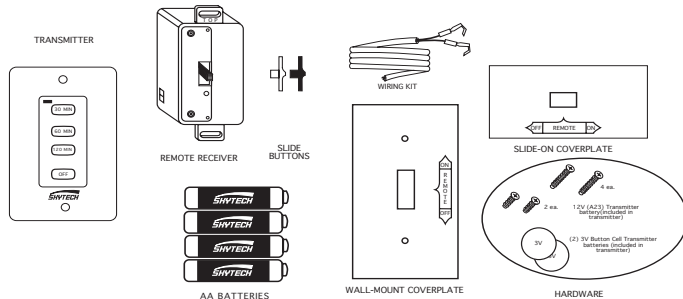

THE SKYTECH™/R-1 MUST BE INSTALLED EXACTLY AS OUTLINED IN THESE INSTRUCTIONS COMPLETELY BEFORE ATTEMPTING INSTALLATION. FOLLOW INSTRUCTIONS CAREFULLY DURING INSTALLATION. ANY MODIFICATION OF THE SKYTECH™/R-1 OR ANY OF ITS COMPONENTS WILL VOID THE WARRANTY AND MAY POSE A FIRE HAZARD.

WALL MOUNT TIMMER

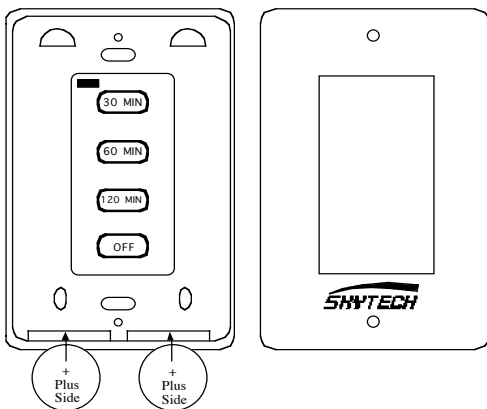

The wall timer operates on a (2) 3V button cell batteries (included) made specifically for remote controls and electronic lighters. Before using the wall timer, install the two (2) 3V button cell batteries. Follow instructions below.

The wall timer has a 30 minute, 60 minute, 120 minute, and a OFF position Upon initial use, there may be a delay of five seconds before the remote receiver will respond to the wall timer.

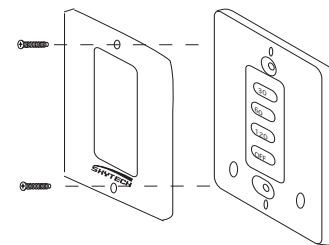

TO INSTALL BATTERIES

1. Remove face from backing plate (Attached with (2) screws as shown to the right) then locate the (2) holders for the 3V button cell batteries.
2. Slide the button cell batteries into the battery holders. (Make sure that the batteries are installed with the (+) plus side facing up).
3. After the batteries are installed replace the face plate and the (2) screws.

TO REMOVE THE BATTERIES

1. Remove face from backing plate (Attached with (2) screws as shown at the right) then locate the (2) holders for the 3V button cell batteries.
2. Insert a small screwdriver into the slot above the button cell battery and push the battery out (Slots shown to the right).
3. After the batteries are installed replace the face plate and the (2) screws.

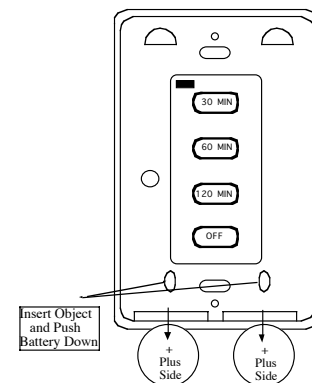

WALL MOUNTING THE TIMER

1. Remove face from backing plate and locate the (2) two holes that mount the plate to the wall.
2. Locate the (2) two mounting holes and mark the holes on the wall.
3. Use the (2) two dry wall anchors and screws (that are supplied) to mount the base plate to the wall as shown.
4. Thermostat can also be mounted onto an existing (Plastic) electrical box.
5. Base plate should be mounted level on the wall for best operation.

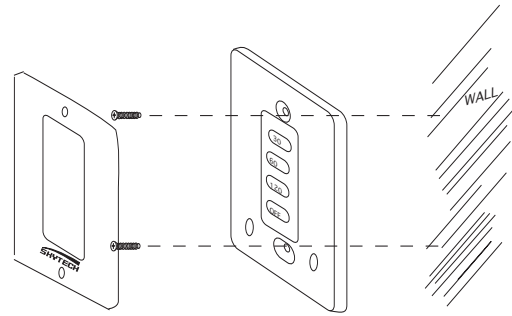
**REMOTE RECEIVER**

IMPORTANT: THE REMOTE RECEIVER SHOULD BE POSITIONED WHERE AMBIENT TEMPERATURES DO NOT EXCEED 130 DEGREE F.

The remote receiver (right) operates on four 1.5V AA- size batteries (Included). It is recommended that ALKALINE batteries be used for longer battery life and maximum microprocessor performance. **IMPORTANT:** New or fully charged batteries are essential to proper operation of the remote receiver.

NOTE: The remote receiver will only respond to the transmitter when the 3-position slide button on the remote receiver is in the **REMOTE** (center) position.

The remote receiver houses the microprocessor that responds to commands from the wall timer to control system operation. The remote receiver has a 3-position slide switch (see figure at right) for selecting the mode of operation: **ON/REMOTE/OFF**.

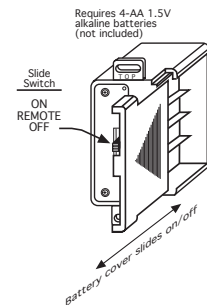

- With the slide switch in the **ON** position (toward the word TOP), the system will remain on until the slide switch is placed in the OFF or REMOTE position. This manual switch will turn **ON** or **OFF** the system, without the wall timer or good batteries.
- With the slide switch in the REMOTE position (centered), the system will only operate if the remote receiver receives commands from the wall timer. **Upon initial use or after an extended period of no use the ON button must be pressed for up to five seconds.**
- With the slide switch in the **OFF** position (away from the word TOP), the system is off.
- It is suggested that the slide switch be placed in the OFF position if you will be away from your home for an extended period of time. If the remote receiver is mounted out of children's reach, placing the slide switch in the OFF position also functions as a safely "lock out" by both turning the system off and rendering the wall timer inoperative.

INSTALLATION

NOTE: When the remote receiver is installed as a wall switch, It is recommended that it be installed in a PLASTIC switch box. Remote functions may not operate properly if the remote receiver is installed in a steel switch box.

Make sure the remote receiver switch is in the **OFF** position (toward the small hole on the receiver's face). It is recommended that 18 gauge, stranded wires (Included) be used for wire installation between the terminal wiring block on the millivolt gas valve or electronic ignition system and the wire terminals on the remote receiver. For best results, use 18-gauge wire that has not been spliced and measuring no longer than 20 ft.

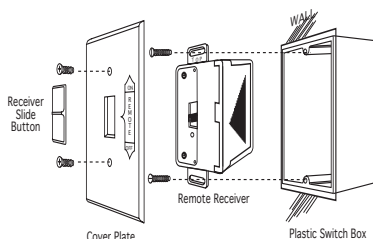
WALL MOUNT

Install four 1.5V AA-size ALKALINE batteries (Included) in the remote receiver. For best performance, remote receiver batteries should be factory fresh when installed. Very little battery power is required to operate the remote receiver, but the electronics are turned to operate best when battery output is greater than 5.3 volts. For new AA batteries should provide an output voltage of 6.0 to 6.2 volts.

Position the remote receiver so the word TOP is facing up, then install the remote receiver into the plastic switch box using the two long screws provided. Install the cover plate using the two short screws provided.

Push the remote receiver slide button over the remote receiver slide switch. Reverse installation of the slide button if it appears off center.

HEARTH MOUNT

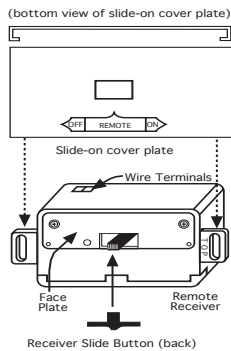

The remote receiver can be placed on the fireplace hearth or under the fireplace, behind the control Access panel.
 Position where the ambient temperature does not exceed 130 degrees F. With the battery compartment on the bottom, install the slide-on cover and receiver slide button. Reverse installation of the slide button if it appears off center.

PROTECTION FROM EXTREME HEAT IS VERY IMPORTANT. Like any piece of electronic equipment, the remote receiver should be kept away from temperatures exceeding 130 degrees F. Battery life is also significantly shortened if batteries are exposed to high temperatures.

WIRING INSTRUCTIONS

WARNING

DO NOT CONNECT REMOTE RECEIVER DIRECTLY TO 110-120 VAC POWER. THIS WILL BURN OUT THE REMOTE RECEIVER AND THE ELECTRONIC MODULE. CONSULT GAS APPLIANCE MANUFACTURER'S INSTRUCTIONS AND WIRING SCHEMATICS FOR PROPER PLACEMENT OF ALL WIRES. ALL ELECTRONIC MODULES ARE TO BE WIRED TO MANUFACTURER'S SPECIFICATIONS

THE DIAGRAMS THAT FOLLOW ARE FOR ILLUSTRATION PURPOSES ONLY. FOLLOW INSTRUCTIONS FROM MANUFACTURER OF GAS VALVE AND/OR ELECTRONIC MODULE FOR CORRECT WIRING PROCEDURES. IMPROPER INSTALLATION OF ELECTRIC COMPONENTS CAN CAUSE DAMAGE TO ELECTRONIC MODULE, GAS VALVE, AND REMOTE RECEIVER.

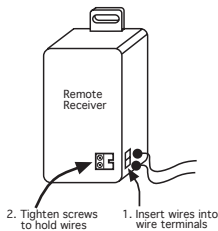

A qualified electrician or a gas technician who is familiar with the gas appliance and gas valves that will be operated by this remote should install this remote control system. Incorrect wiring connections **WILL** cause damage to the gas valve or electronic module operating the gas appliance and may also damage the remote receiver. Attach the two 18 gauge wires provided to the receiver as shown.

WIRING MILLIVOLT VALVES

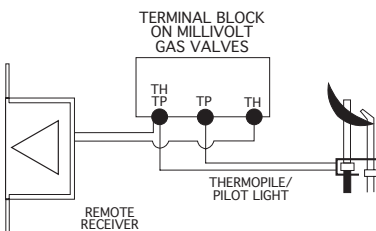

Installer must connect two 18 gauge wires from the remote receiver to the TH and TH/TP terminals on the millivolt gas valve. (It does not matter which receiver wires are connected to the designated terminals listed above.)

Operation of the remote receiver is similar to a wall switch in that both turn the gas valve on and off. The remote receiver's input signals come from the ON/OFF buttons on the transmitter.

WIRING ELECTRONIC SPARK IGNITIONS

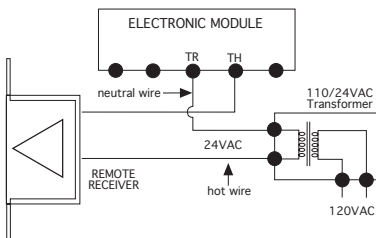

Connect the neutral wire from the 24VAC transformer to the TR (transformer) terminal on the ELECTRONIC MODULE. Connect the hot wire from the 24VAC transformer to either of the wire terminals on the remote receiver. Connect another wire (included) between the other receiver wire terminal and the TH (thermostat) terminal on the ELECTRONIC MODULE.

BATTERY LIFE

Life expectancy of alkaline batteries in the SKYTECH TM/R-1 should be at least 12 months. Replace all batteries annually. When the wall timer no longer operates the receiver. Or the remote receiver does not function at all; the batteries should be checked. It is important that the remote receiver batteries are fully charged, providing a combined output voltage of at least 5.3 volts. The length of the wire between the remote receiver and the gas valve directly affects the operating performance of the remote system. The longer the wire, the more battery power is required to deliver signals between the remote receiver and the gas valve. The wall timer should operate with as little as 4.0 volts battery power, Measured at the (2) 3 volt button cell batteries.

TROUBLE SHOOTING

If you encounter problems with your fireplace system, the problem may be with the fireplace itself or it could be with the SKYTECH wall timer system. Review the fireplace manufacturer's operation manual to make sure all connections are properly made. Then check the operation of the SKYTECH system in the following manner:

- Make sure the batteries are correctly installed in the RECEIVER. One reversed battery will keep receiver from operating properly.
- Check batteries in WALL THERMOSTAT to make sure contacts are touching (+) and (-) ends of button cell batteries.
- Keep RECEIVER from temperatures exceeding 130 degrees F. Battery life shortened when ambient temperatures are above 115 degrees F.
- If RECEIVER is installed in tightly enclosed metal surround, the operating distance will be shortened. Reposition RECEIVER into "free air" space.

FREQUENCY (DISTANCE) ADJUSTMENT PROCEDURE

Due to the location of the receiver in the appliance. The receiver may be subjected to hot and cold conditions this may cause the frequency to change. Follow instructions below to make the adjustment: Check the battery level, if low, replace all batteries.

1. Remote face plate of the timer from the base plate and locate the adjustment hole.
2. Using a small screwdriver, (eyeglass screwdriver works best) turn the adjustment screw clock wise, no more than 1degree -2 degrees. Just a slight movement of this screw should improve the operating distance. If turning clockwise does not fix the problem, return screw to original position and turn 1 degree- 2 degrees counter-clockwise. This procedure is like turning your radio. Too much adjustment will cause complete loss of frequency match between the transmitter and receiver. You should not have to turn the adjustment screw more than 5 degrees, 1/8 turn, in either direction to improve operating distance.
3. Replace the face of the timer to the base plate.

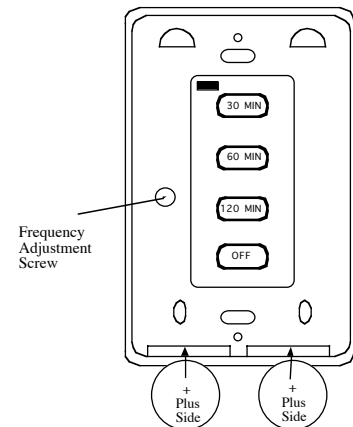

SPECIFICATIONS

Batteries: Transmitter (2) 3V Button Cell Batteries
 Batteries: Remote Receiver 6V-4 ea AA 1.5V ALKALINE FCC ID No's: TRANSMITTER -K9LTN-R-1; RECEIVER: K9L2001R
 Operating Frequency: 303.875MHz Canadian ISC No.'s: TRANSMITTER -2439A-TM-R-1; RECEIVER- 2439-101-521A

FCC REQUIREMENTS

NOTE: THE MANUFACTURER IS NOT RESPONSIBLE FOR ANY RADIO OR TV INTERFERENCE CAUSED BY UNAUTHORIZED MODIFICATIONS TO THIS EQUIPMENT. SUCH MODIFICATIONS COULD VOID THE USER'S AUTHORITY TO OPERATE THE EQUIPMENT

WARRANTY

All warranty information is listed on the warranty sheet packed with this product. If you did not receive this warranty sheet, please contact Skytech Systems, Inc. at the following:
 9230 Conservation Way, Fort Wayne, IN 46809
 (888) 672-8929 or (260) 459-1703

FOR TECHNICAL SERVICE CALL:

U.S. INQUIRIES
 888/672-8929 or
 260/459-1703

CANADIAN INQUIRIES
 877/472-3923

Website: skytechsystem.com

MANUFACTURED EXCLUSIVELY FOR SKYTECH II, INC